

10 Corrugated @ Door Header - CMU  
6" = 1'-0"

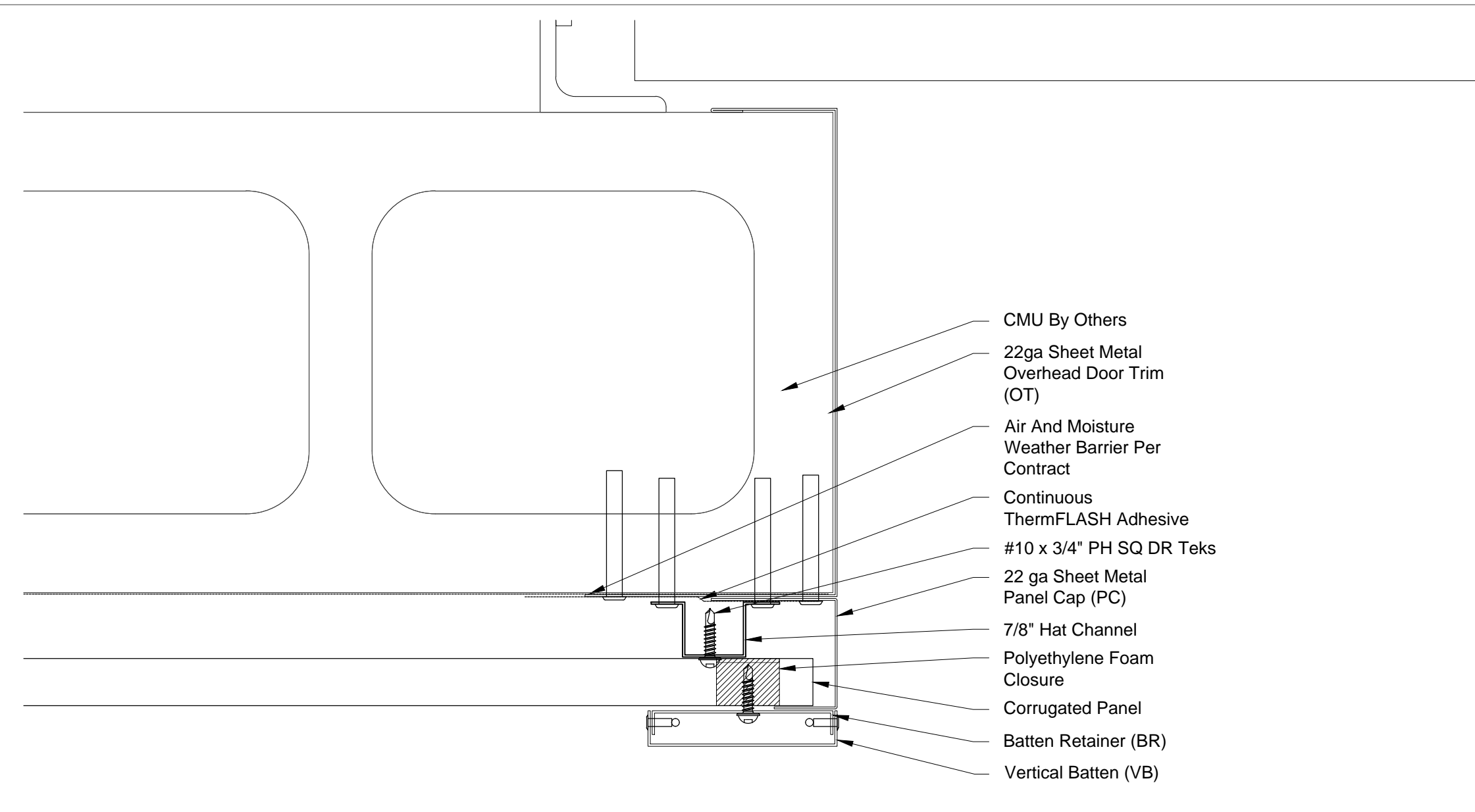

13 Corrugated @ Overhead Door Jamb - CMU  
6" = 1'-0"

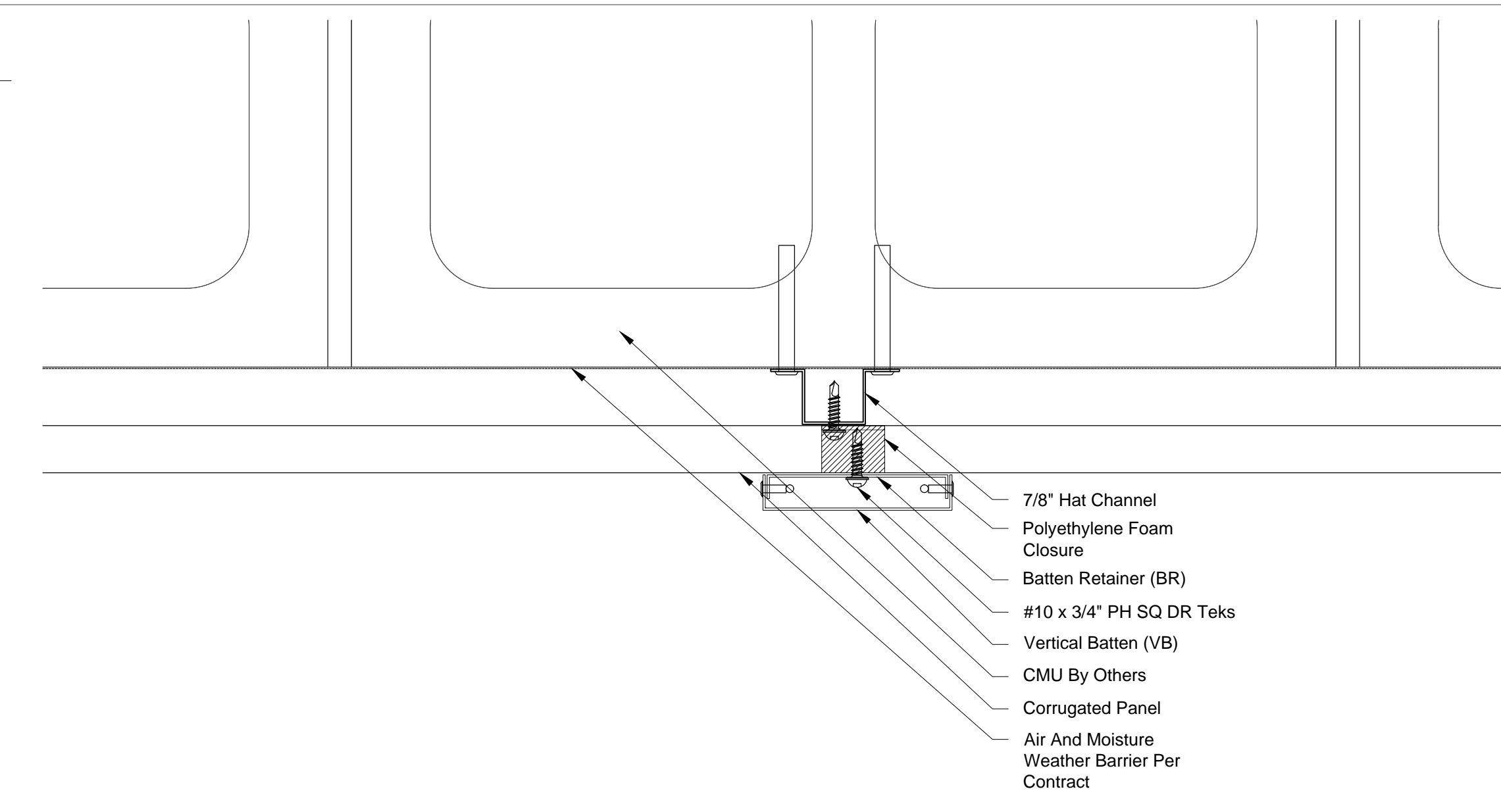

16 Corrugated @ Vertical Batten - CMU  
6" = 1'-0"

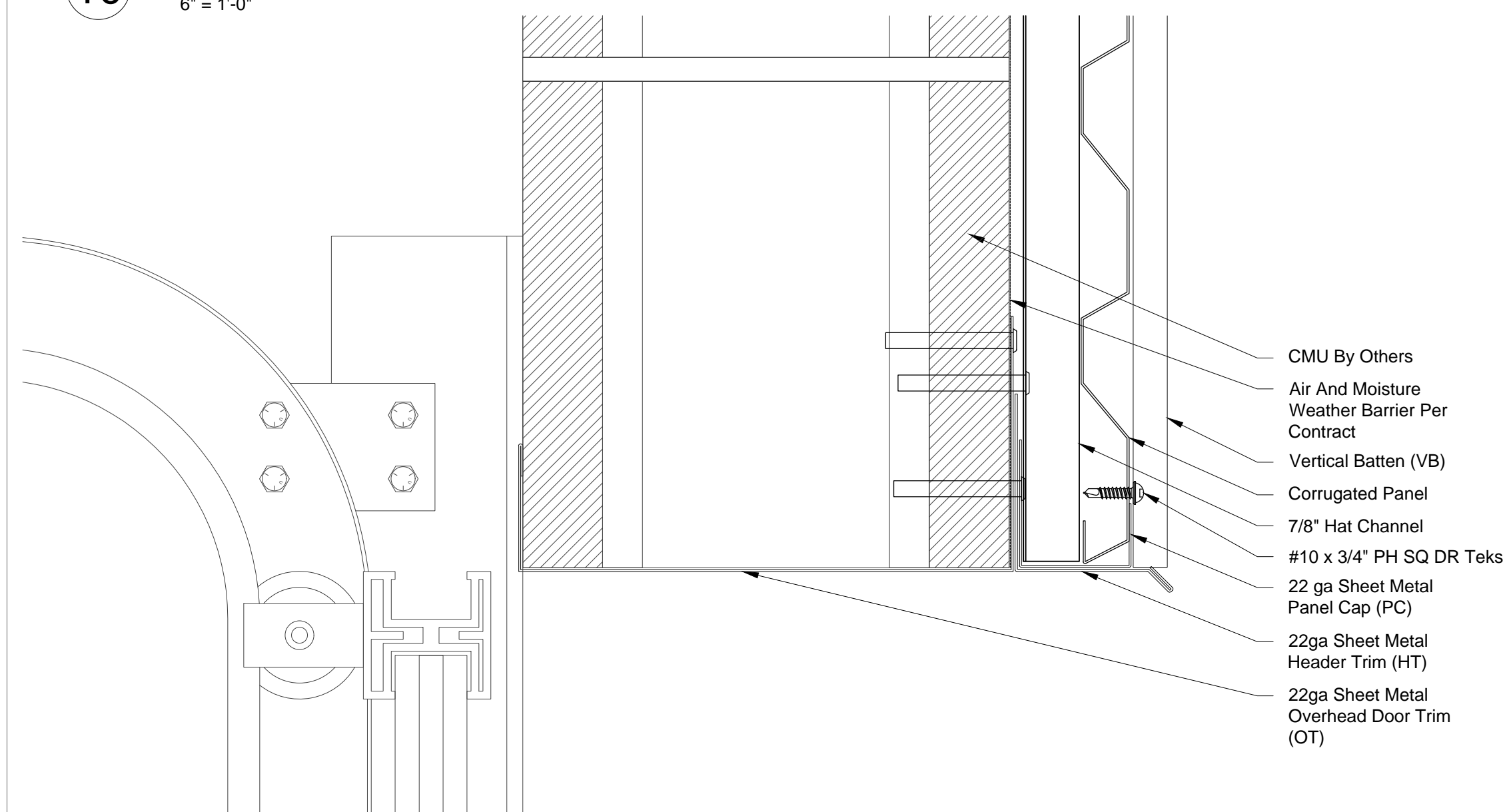

11 Corrugated @ Overhead Door Header - CMU  
6" = 1'-0"

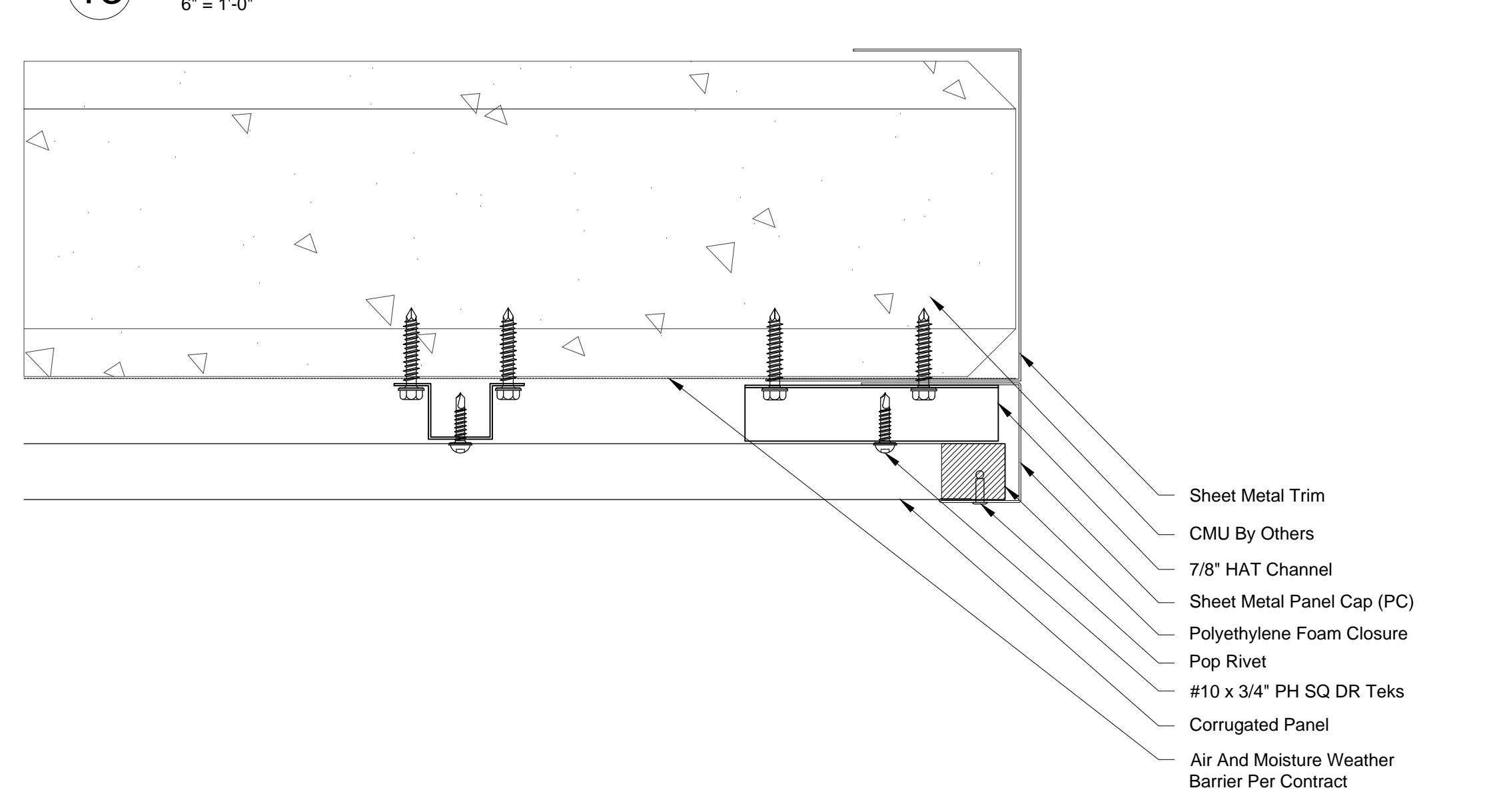

14 Corrugated @ Parapet End Cap - CMU  
6" = 1'-0"

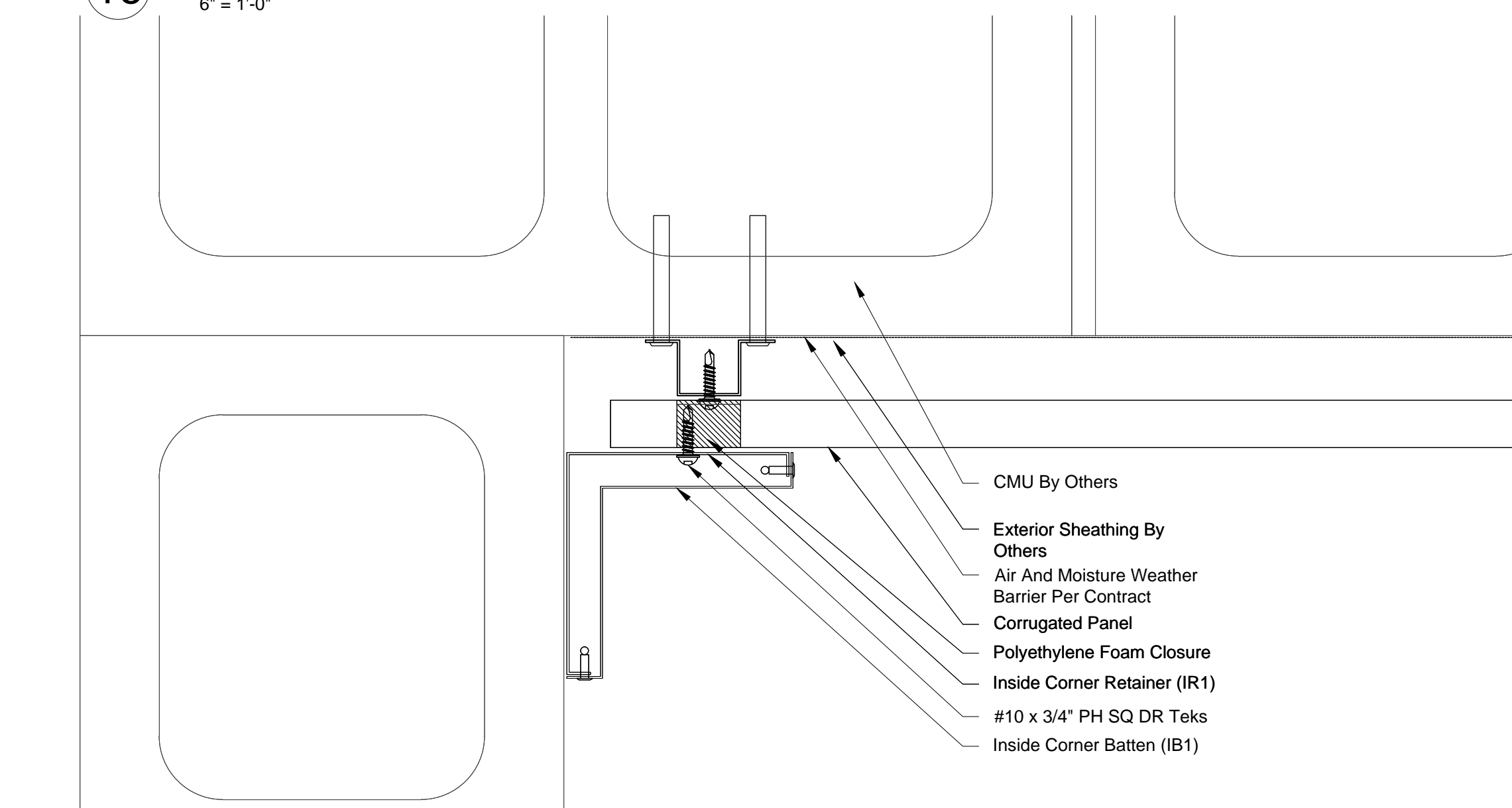

17 Corrugated @ Termination - CMU  
6" = 1'-0"

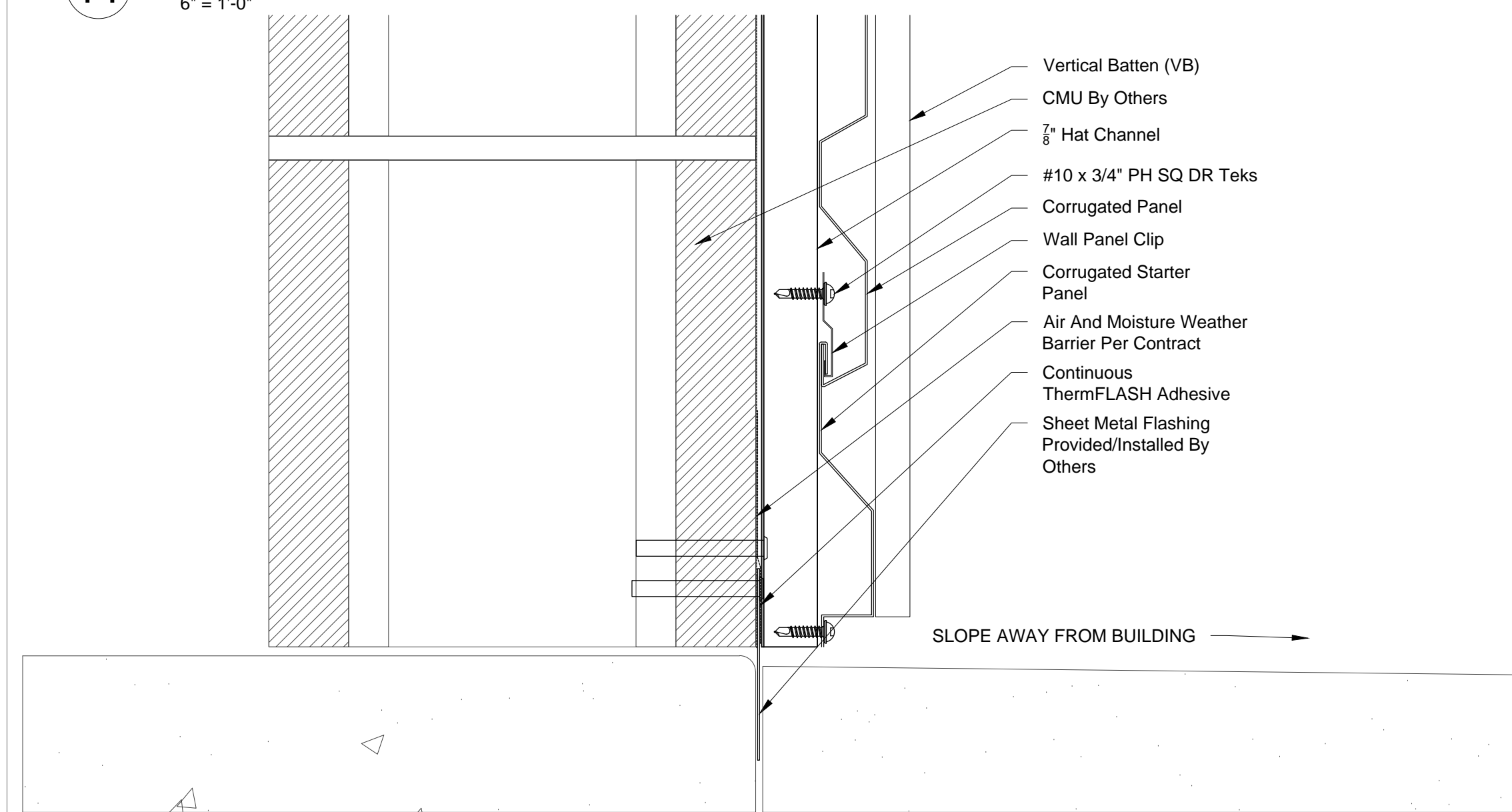

12 Corrugated @ Base Condition - CMU  
6" = 1'-0"

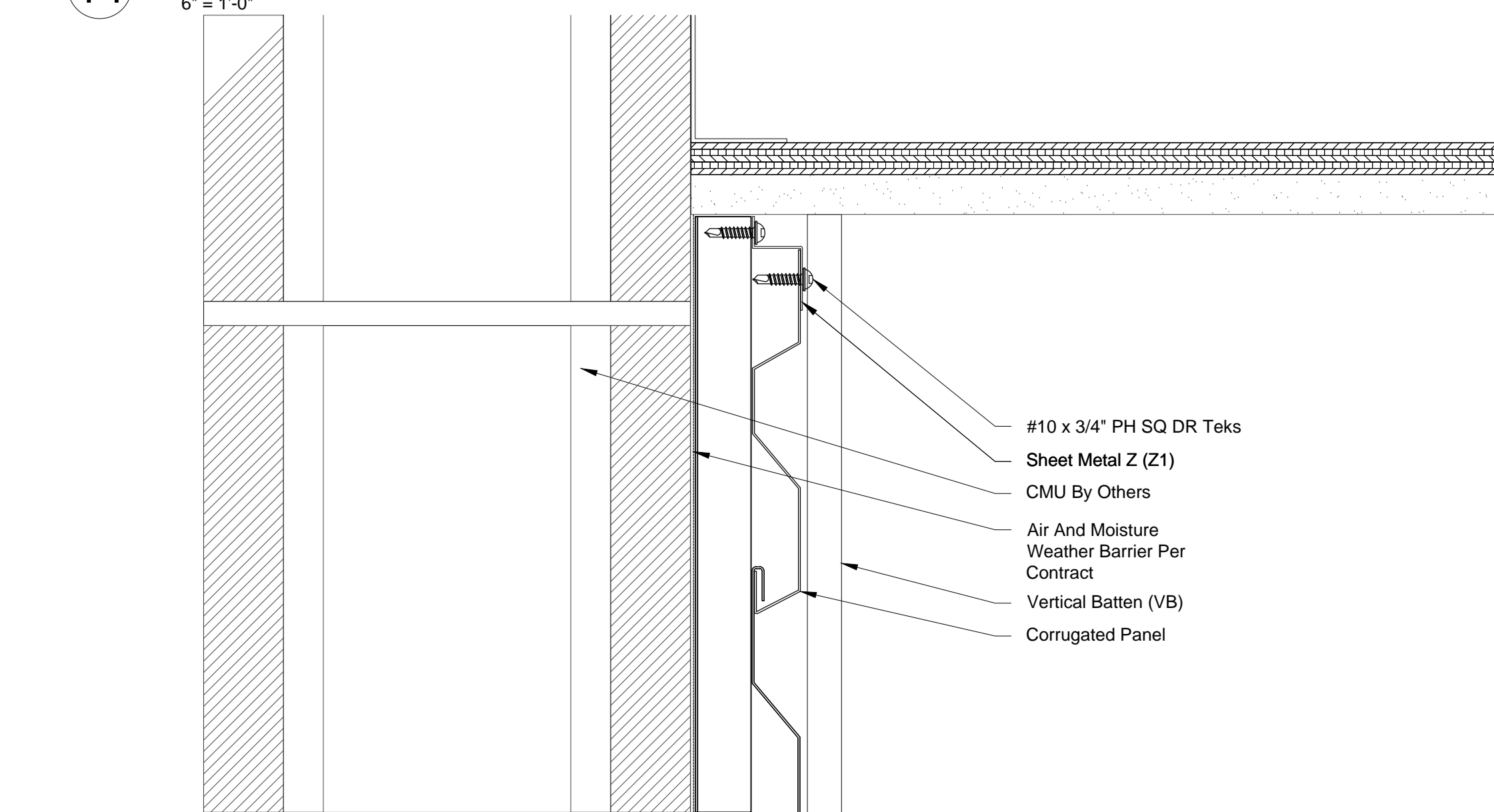

15 Corrugated @ Soffit Termination - CMU  
6" = 1'-0"

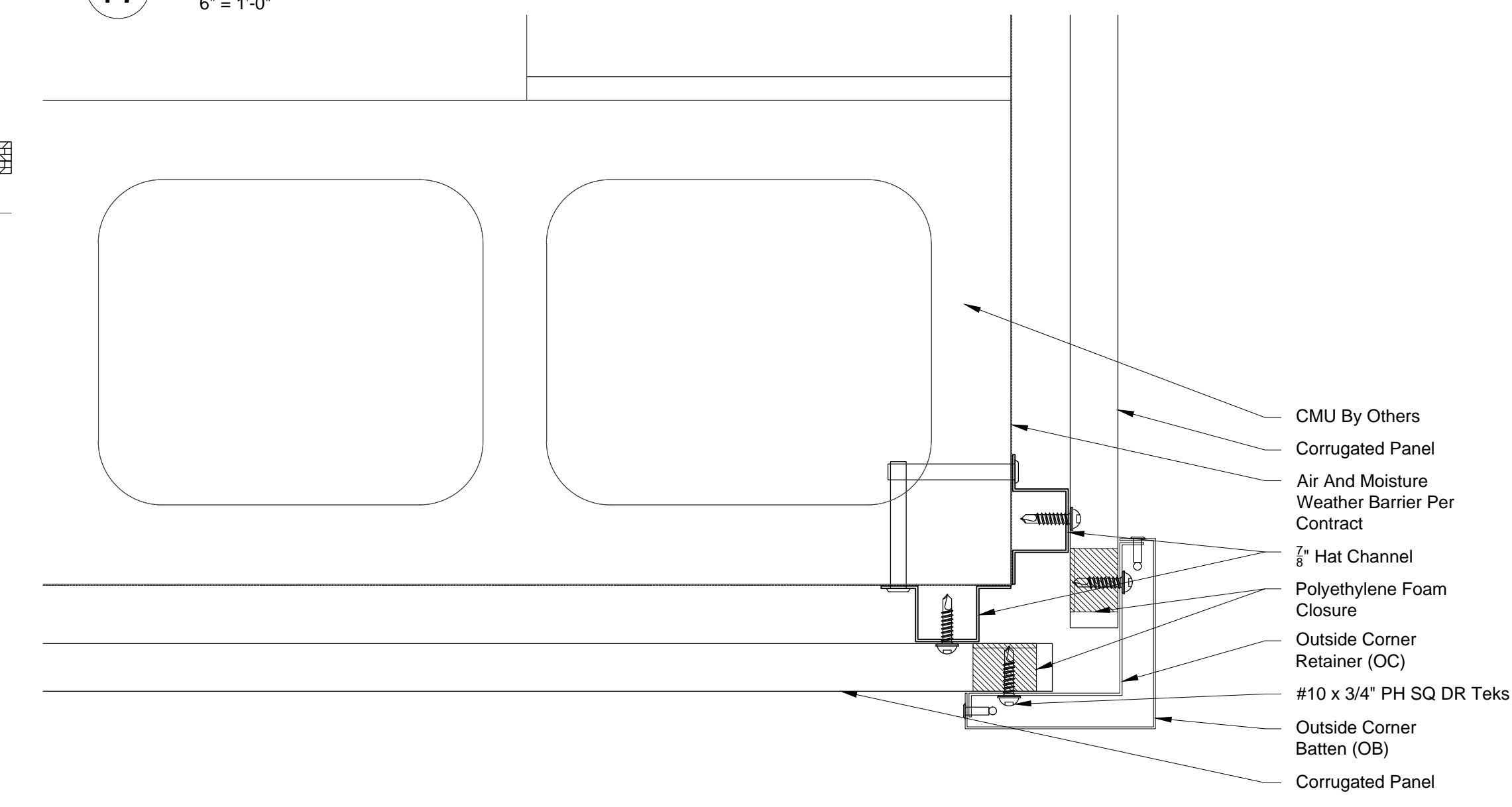

18 Corrugated @ Outside Corner - CMU  
6" = 1'-0"

## Standard Corrugated CMU Details

IF YOU ARE INTERESTED IN USING THESE DETAILS IN YOUR DESIGN SHEETS, PLEASE CONTACT BESTWORTHROMMEL FOR ADDITIONAL CAD DRAWINGS, OR FURTHER INFORMATION REGARDING OUR PANEL SYSTEMS.



**BESTWORTHROMMEL**  
19818 74TH Ave. N.E.  
Arlington, WA 98223  
360.435.2927 PHONE - 360.435.3617 FAX  
www.bestworth.com